

# Data Sheet



Article number: 5863503101

Description: Ball Valve 350.310/1, G 1/2" - G 1/2"  
Thread/Thread

## Measures

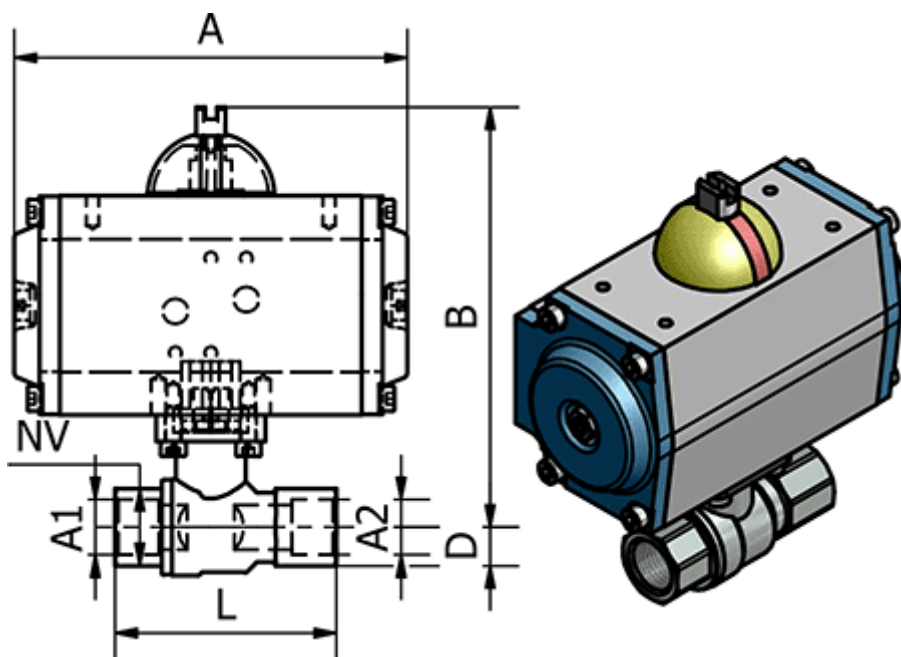

A	= 116
B	= 133
Connecting A1	= G 1/2"
Connecting A2	= G 1/2"
D	= 17
L	= 75
Max. Operating Pressure	= 40 bar
NV	= 26